

Banana Plugs and Jacks

Just need a reliable plug or jack? Making your own test set? Pomona Electronics' selection is designed to meet demanding electrical characteristics. Nickel-plated plugs feature brass bodies and one-piece heat-treated beryllium copper springs with nylon or ABS insulation. Choose Pomona for the reliable and dependable connections your work demands.

Pomona

ELECTRONICS

29

Double Banana Plug with Wire Guide, Stackable, Solderless

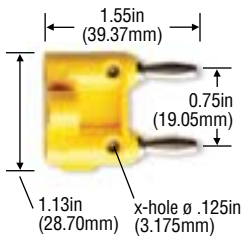

Model#	Plating	Insulation	*Std. Colors
MDP-*	Nickel	ABS	-0 Black, -1 Brown, -2 Red, -3 Orange, -4 Yellow, -5 Green, -6 Blue, -7 Violet-8 Gray, -9 White
4892-*	Gold	ABS	-0 Black, -2 Red
4898-*	Nickel	Polyphenylene Sulfide	-0 Black, -6 Blue
4914			Set screws 8-32 x 0.210in (5.33mm), 100/pk

Set screws secure wire. Simplifies cable construction or component mounting. Accepts cables to 0.22in (5.59mm) dia. max., (18-22 AWG wire).

Material: Banana Plug/Jack: brass; Spring: heat treated beryllium copper; finish: nickel plating.

Rating: For CE compliance and for personal safety, do not hold in hand when voltages exceed 33 Vrms/70 Vdc. Maximum voltage for hands free use: 5000 Vdc. Do not use on circuits where transient stresses can exceed the rated voltage. 15A, +122°F (+50°C) (Model 4898, +302°F (+150°C) max.).

Double Banana Plug with Solder Turret Terminals

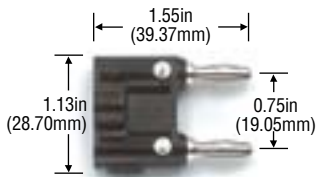

Model# MDP-ST

Similar to MDP above except with bright tin plated solder turrets. Accepts cables to 0.215in (5.46mm) dia. max.

Material: Banana Plug/Jack: brass; Spring: heat treated beryllium copper; Finish: nickel plating; Insulation: polypropylene.

Rating: For CE compliance and for personal safety, do not hold in hand when voltages exceed 33 Vrms/70 Vdc. Maximum voltage for hands free use: 5000 Vdc. Do not use on circuits where transient stresses can exceed the rated voltage. 15A, +131°F (+55°C) max.

Color: Black

Model# 4914

Set screws 8-32 x 0.210in (5.33mm), 100/pk

Double Banana Plug with Solder Turret Terminals

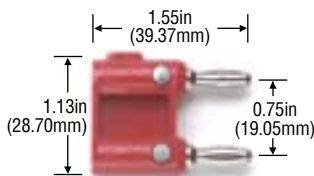

Model# 1330-ST-*

Similar to Model 1330 above, but features bright tin plated solder turrets.

Material: Banana Plug/Jack: brass; Spring: heat treated beryllium copper; Finish: nickel plating; Insulation: polypropylene.

Rating: For CE compliance and for personal safety, do not hold in hand when voltages exceed 33 Vrms/70 Vdc. Maximum voltage for hands free use: 5000 Vdc. Do not use on circuits where transient stresses can exceed the rated voltage. 15A, +122°F (+50°C) max.

*Std. Colors: -0 Black, -2 Red.

Double Banana Plug with Shorting Bar

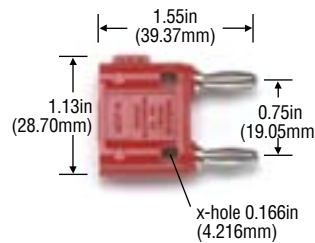

Model# MDP-S-*

Banana plugs internally shorted with #18 AWG wire.

X-hole accepts standard banana plug.

Material: Banana Plug/Jack: brass; Spring: heat treated beryllium copper; Finish: nickel plating; Insulation: ABS.

Rating: For CE compliance and for personal safety, do not hold in hand when voltages exceed 33 Vrms/70 Vdc. Maximum voltage for hands free use: 5000 Vdc. Do not use on circuits where transient stresses can exceed the rated voltage. 15A, +122°F (+50°C) max.

*Std. Colors: -0 Black, -2 Red, -9 White.

Model# 4914

Set screws 8-32 x 0.210in (5.33mm), 100/pk.

Double Banana Plug, Stackable, Solderless

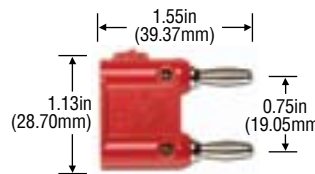

Model# 1330-*

Similar to MDP without cable loop.

Features recess for mounting small components with set screws.

Model 1330 has setscrews like MDP.

Material: Banana Plug/Jack: brass; Spring: heat treated beryllium copper; Finish: nickel plating; Insulation: ABS.

Rating: For CE compliance and for personal safety, do not hold in hand when voltages exceed 33 Vrms/70 Vdc. Maximum voltage for hands free use: 5000 Vdc. Do not use on circuits where transient stresses can exceed the rated voltage. 15A, +122°F (+50°C) max.

*Std. Colors: -0 Black, -2 Red.

Model# 4914

Set screws 8-32 x 0.210in (5.33mm), 100/pk.

Isolated Double Banana Plug with Four Solder Terminals

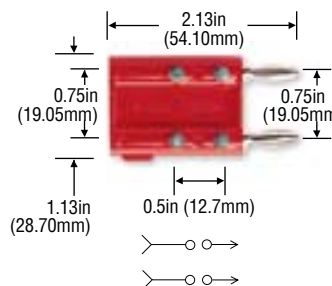

Model# MDP-X

Use to make your own attenuator, balun or filter. Jacks are isolated from plugs.

Material: Banana Plug/Jack: brass; Spring: heat treated beryllium copper; Finish: nickel plating; Insulation: polypropylene; Solder turrets; bright tin plated.

Rating: For CE compliance and for personal safety, do not hold in hand when voltages exceed 33 Vrms/70 Vdc. Maximum voltage for hands free use: 2500 Vdc. Do not use on circuits where transient stresses can exceed the rated voltage. 15A, +131°F (+55°C) max.

Color: Red.

Isolated Double Banana Plug with Three Solder Terminals

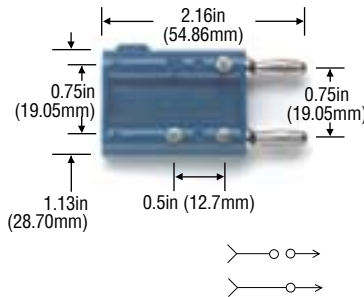

Model# 1837

Use to make your own attenuator, balun or filter.

One jack is isolated.

Material: Banana Plug/Jack: brass; Spring: heat treated beryllium copper; Finish: nickel plating; Insulation: polypropylene; Solder turrets; bright tin plated.

Rating: For CE compliance and for personal safety, do not hold in hand when voltages exceed 33 Vrms/70 Vdc. Maximum voltage for hands free use: 2500 Vdc. Do not use on circuits where transient stresses can exceed the rated voltage. 15A, +131°F (+55°C) max.

Color: Blue.

Isolated Single Banana Plug with Two Solder Terminals

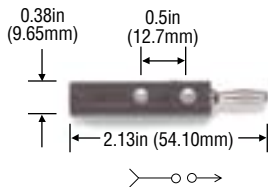

Model# 1390-*

Ideal for computers, lab circuit design and testing.

Jack is isolated from plug.

Material: Banana Plug/Jack: brass; Spring: heat treated beryllium copper; Finish: nickel plating; Insulation: polypropylene; Solder turrets; bright tin plated.

Rating: For CE compliance and for personal safety, do not hold in hand when voltages exceed 33 Vrms/70 Vdc. Maximum voltage for hands free use: 2500 Vdc. Do not use on circuits where transient stresses can exceed the rated voltage. 15A, +131°F (+55°C) max.

***Std. Colors:** -0 Black, -2 Red.

QUAD Stacking Plug

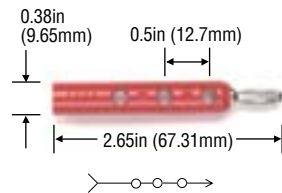

Model# 3364-*

Features one in-line stacking and three cross-stacking connections.

All jacks are connected to plug.

Material: Banana Plug/Jack: brass; Spring: heat treated beryllium copper; Finish: nickel plating; Insulation: ABS.

Rating: For CE compliance and for personal safety, do not hold in hand when voltages exceed 33 Vrms/70 Vdc. Maximum voltage for hands free use: 5000 Vdc. Do not use on circuits where transient stresses can exceed the rated voltage. 15A, +122°F (+50°C) Max.

***Std. Colors:** -0 Black, -2 Red.

Triple Banana Plug, Stackable, Solderless

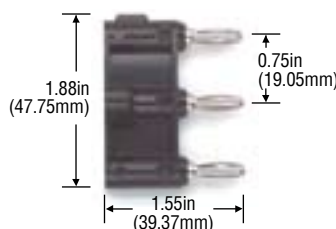

Model# 2970-*

Use for balanced line 2 conductor shielded cable assemblies. Accepts cables to 0.250in (6.35mm) dia. max., Setscrews secure wires.

Material: Banana Plug/Jack: brass; Spring: heat treated beryllium copper; Finish: nickel plating; Insulation: ABS.

Rating: For CE compliance and for personal safety, do not hold in hand when voltages exceed 33 Vrms/70 Vdc. Maximum voltage for hands free use: 5000 Vdc. Do not use on circuits where transient stresses can exceed the rated voltage. 15A, +122°F (+50°C) max.

***Std. Colors:** -0 Black, -2 Red.

4mm Safety Banana Jack to Banana Plug Adapter



Model# 6728

Accepts safety-sheathed 4mm banana plug and adapts to standard banana plug.

Material: nickel plated brass.

Rating: For CE compliance and for personal safety, do not hold in hand when voltages exceed 33 Vrms/70 Vdc. Maximum voltage for hands free use: 2500 Vdc. Do not use on circuits where transient stresses can exceed the rated voltage. 15A, +131°F (+55°C) max.

***Std. Colors:** -0 Black, -2 Red.

Double Banana Plug Splice

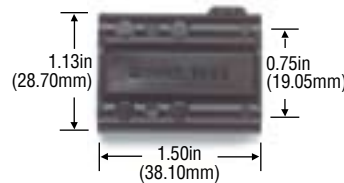

Model# 1823-*

Provides rapid method for splicing cables.

Rating: For CE compliance and for personal safety, do not hold in hand when voltages exceed 33 Vrms/70 Vdc. Maximum voltage for hands free use: 5000 Vdc. Do not use on circuits where transient stresses can exceed the rated voltage. 15A, +131°F (+55°C) max.

***Std. Colors:** -0 Black, -2 Red.

Single Banana Plug Splice

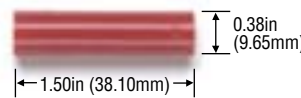

Model# 1829-*

Provides rapid method for splicing single banana plug patch cords.

Rating: For CE compliance and for personal safety, do not hold in hand when voltages exceed 33 Vrms/70 Vdc. Maximum voltage for hands free use: 5000 Vdc. Do not use on circuits where transient stresses can exceed the rated voltage. 15A, +55°C (+131°F) max.

***Std. Colors:** -0 Black, -2 Red.

Insulated Double Banana Plug Shorting Bar

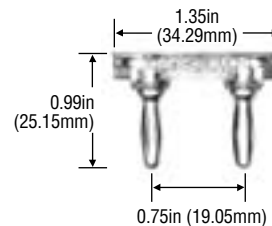

Model# 5145

Shorting bar is completely insulated in clear ABS thermoplastic.

Fits standard 0.166in (4.22mm) dia. banana jack.

Material: Banana Plug Body: brass; Spring: beryllium copper; Finish: nickel plating.

Rating: 15A, +122°F (+50°C) max., resistance less than 1.5mΩ.

Do-It-Yourself 4mm Stackable Banana Plug, Solder



Model# 6721

Build your own safety stacking leads with do-it-yourself safety-sheathed 4mm stackable banana plugs.

Material: Contacts: nickel-plated brass, Insulation: lucel acetal polymer.

Rating: IEC61010 1000V Category III**, 20A, 14 to 176°F (-10 to +95°C).

***Std. Colors:** -0 Black, -2 Red.

** When plug is correctly assembled and terminated.

Banana Plugs and Jacks

Do-It-Yourself In-Line Sheathed (4mm) Banana Plug and Jack

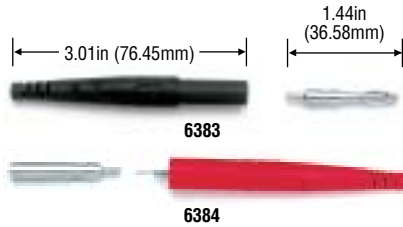

Safety-rated plugs and jacks for use with any wire from 22 to 18 AWG with flexible insulation.

Attaches to wire by crimp or soldering.

Plugs fit most sheathed DMM jacks and DMM test leads to make up your own banana plug or jack test lead or jumper.

See mating panel jacks (6387 on page 33).

Material: Banana Plug/Jack: brass; Spring: heat treated beryllium copper; Insulation: Santoprene®.

Rating: CAT II 300V, 15A, +275°F (+135°C) max.

*Std. Colors: -0 Black, -2 Red, -02 Black and Red (2 per pkg).

*Sold in pkgs of 10.

Model#	
6383-*	Plug
6383-02	
6384-*	Jack
6384-02	

Do-It-Yourself Solderless Stackup Banana Plug with Safety Shield

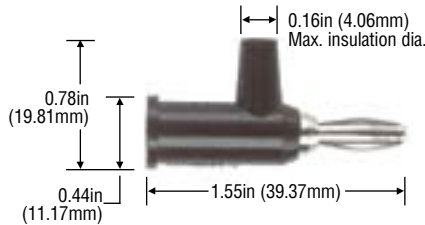

Internal set screw holds wire firmly.

Safety collar insulates exposed wire leads.

Accepts standard banana plug and fits 0.166in (4.22mm) dia. banana jack.

Material: Banana Plug/Jack: brass; Spring: heat treated beryllium copper.

Rating: For CE compliance and for personal safety, do not hold in hand when voltages exceed 33 Vrms/70 Vdc. Maximum voltage for hands free use: 5000 Vdc. Do not use on circuits where transient stresses can exceed the rated voltage. 15A, +122°F (+50°C) max. (Model 4899, +302°F (+150°C) max.).

Accepts 18-22 AWG wire.

Model#	Plating	Insulation	Std. Colors
1825-*	Nickel	ABS	-0 Black, -1 Brown, -2 Red, -3 Orange, -4 Yellow, -5 Green, -6 Blue, -7 Violet, -8 Gray, -9 White. Sold in pkgs of 10
4897	Gold	ABS	-0 Black, -2 Red
4899	Nickel	Polyphenylene Sulfide	-0 Black, -6 Blue Sold in pkgs of 10
6545	Nickel	ABS	Pkg of 1 ea. of all 10 colors

Do-It-Yourself Solderless Stackup Banana Plug

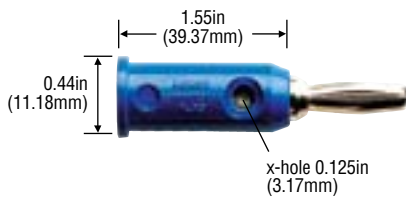

4914 set screws 8-32 x 0.210 (5.33mm), 100/pk.

Internal set screw holds wire firmly.

Accepts standard banana plug, fits standard 0.166in (4.22mm) dia. banana jack.

Material: Banana Plug/Jack: brass; Spring: heat treated beryllium copper.

Rating: For CE compliance and for personal safety, do not hold in hand when voltages exceed 33 Vrms/70 Vdc. Maximum voltage for hands free use: 5000 Vdc. Do not use on circuits where transient stresses can exceed the rated voltage. 15A, +122°F (+50°C) max. (Model 5230, +302°F (+150°C) max.).

Accepts 18-22 AWG wire.

Model#	Plating	Insulation	Std. Colors
1325-*	Nickel	ABS	-0 Black, -1 Brown, -2 Red, -3 Orange, -4 Yellow, -5 Green, -6 Blue, -7 Violet, -8 Gray, -9 White.
5406	Gold	ABS	-0 Black, -2 Red
5230	Nickel	Polyphenylene Sulfide	-0 Black, -6 Blue
6546	Nickel	ABS	Pkg of 1 ea. of all 10 colors

*Sold in pkgs of 10.

Do-It-Yourself 4mm Right Angle Banana Plug



Model# 6729

Build your own safety leads with do-it-yourself safety-sheathed 4mm right angle banana plug.

Material: Contacts: nickel-plated brass; Insulation: lucel acetal polymer.

Rating: IEC61010 1000V Category III**, 20A, 14 to 176°F (-10 to +55°C).

*Std. Colors: -0 Black, -2 red.

** When plug is correctly assembled and terminated.

Do-It-Yourself In-Line Sheathed Banana Plug/Banana Jack

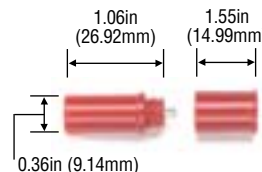

4933/4986 Plugs



4934/4982 Jacks

Model#	Accepts wire AWG	Wire Access Hole	Description
4933-*	22, 20, 18	0.159in (4.04mm) Dia.	Plug
4986-*	16, 14	0.200in (50.8mm) Dia.	Plug
4934-*	22, 20, 18	0.159in (4.04mm) Dia.	Jack

These plugs and jacks are designed to fit together and provide protection from accidental shorting.

Material: Banana Plug/Jack: brass; Spring: beryllium copper; Insulation: nylon.

Rating: For CE compliance and for personal safety, do not hold in hand when voltages exceed 33 Vrms/70 Vdc. Maximum voltage for hands free use: 1200V ac/dc. Do not use on circuits where transient stresses can exceed the rated voltage. 15A, +176°F (+80°C) max.

*Std. Colors: -0 Black, -2 Red.

Do-It-Yourself Retractable Sheath Banana Plug

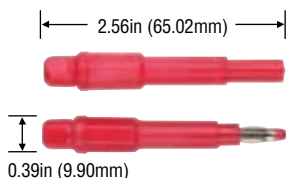

Model#	Color
122505A	Black
122506A	Red

Do-It-Yourself Retractable Sheath Banana Plugs provide fast simple assembly and reliable performance.

Rating: For CE CAT II 300V, CAT III 150V. Maximum voltage for hands free use: 1000 Vrms, 20A, ≤ 2 mΩ.

Accepts 18-22 AWG wire.

Rivet Type Banana Plug

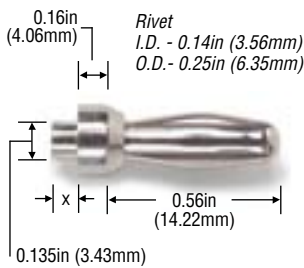

Model#	"X"	Panel
3257	0.094in (2.39mm)	0.062in (1.57mm)
3258	0.125 (3.17mm)	0.093in (2.36mm)

Excellent for riveting to panels or boards.
Fits standard 0.166in (4.22mm) dia. banana jack.

Material: Banana Plug Body: brass; Spring: beryllium copper; Finish: nickel plating.

Rating: For CE compliance and for personal safety, do not hold in hand when voltages exceed 33 Vrms/70 Vdc. Maximum voltage for hands free use: 5000 Vdc. Do not use on circuits where transient stresses can exceed the rated voltage. 15A.

Sold in pkgs. of 10.

Rivet Type Banana Plug with Turret

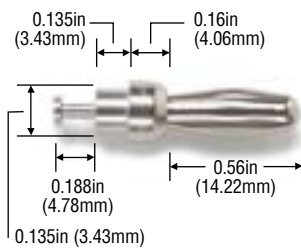

Excellent for riveting to panels or boards. Solder turret for rapid attachment of wires.
Fits standard 0.166in (4.22mm) dia. banana jack.

Material: Banana Plug Body: brass; Spring: beryllium copper; Finish: nickel plating.

Rating: For CE compliance and for personal safety, do not hold in hand when voltages exceed 33 Vrms/70 Vdc. Maximum voltage for hands free use: 5000 Vdc. Do not use on circuits where transient stresses can exceed the rated voltage. 15A.

Sold in pkgs. of 10.

Banana Plug with Threaded Stud and Solder Lug

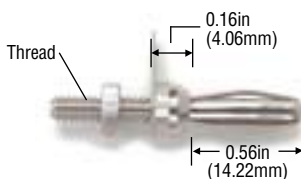

Model#	Thread
3263	6-32 x .50in (12.70mm)
3264	8-32 x .50in (12.70mm)
4512	8-32 x .63in (16.00mm)

Fits standard 0.166in (4.22mm) dia. banana jack.

Material: Banana Plug Body: brass; Spring: beryllium copper; Finish: nickel plating.

Rating: For CE compliance and for personal safety, do not hold in hand when voltages exceed 33 Vrms/70 Vdc. Maximum voltage for hands free use: 5000 Vdc. Do not use on circuits where transient stresses can exceed the rated voltage. 15A.

Sold unassembled, in pkgs. of 10.

Insulated Banana Plug and Jack with Flexible Boot, Solder or Crimp

Model#	Accepts wire AWG	Type	Mates with...
5169-*	22, 20, 18	Plug	Jack 5167
5170-*	16, 14		Jack 5168
5167-*	22, 20, 18	Jack	Plug 5169
5168-*	16, 14		Plug 5170

Ideal for making patch cords or field repairs. Snap-on flexible PVC boot allows wire to be crimped or soldered to banana plug or jack.

Fits standard 0.166in (4.22mm) dia. banana jack.

Material: Boot: Banana Plug Body: brass; Spring: beryllium copper; Finish: nickel plating; Jack: nickel plated brass.

Rating: For CE compliance and for personal safety, do not hold in hand when voltages exceed 33 Vrms/70 Vdc. Maximum voltage for hands free use: 5000 Vdc. Do not use on circuits where transient stresses can exceed the rated voltage. 15A, +122°F (+50°C.) max.

*Std. Colors: -0 Black, -2 Red.



5169/5170 Boots



5167/5168 Jacks

Banana Plug with Screw and Soldering Lug



Model#	Thread
3265	6-32 x 0.25in (6.35mm)
3266	8-32 x 0.25in (6.35mm)

Fits standard 0.166in (4.22mm) dia. banana jack.

Material: Banana Plug Body: brass; Spring: beryllium copper; Finish: nickel plating.

Rating: For CE compliance and for personal safety, do not hold in hand when voltages exceed 33 Vrms/70 Vdc. Maximum voltage for hands free use: 5000 Vdc. Do not use on circuits where transient stresses can exceed the rated voltage. 15A.

Sold unassembled, in pkgs. of 10.

4mm Banana Plug with Threaded M3 Stud



Model# 72918

4mm plug with threaded M3 stud, 2 nuts; 12mm (0.5in) stud length.

Sold unassembled, in pkgs. of 10.

Rating: For CE compliance and for personal safety, do not hold in hand when voltages exceed 33 Vrms/70 Vdc. Maximum voltage for hands free use: 5000 Vdc. Do not use on circuits where transient stresses can exceed the rated voltage. 36A.

Panel Mount IEC61010 Banana Jacks for Sheathed Plugs



72912



72913



72930

Model#	Color	Terminal
72912-0	Black	Threaded Stud
72912-2	Red	
72913-0	Black	Solder Tab
72913-2	Red	
72930*		Threaded Stud, Hexagonal Nut

Material: Gold-plated nickel (72912 and 72913).

Rating: 1000V Cat III, 36A Max.

*Std. Colors: -0 Black, -1 Brown, -2 Red, -4 Yellow, -5 Green, -6 Blue, -7 Violet, -8 Gray, -9 White.

Sold in packages of 10 per color.

Panel Mount IEC61010 4 mm (0.16in) Banana Jack for Sheathed Plugs

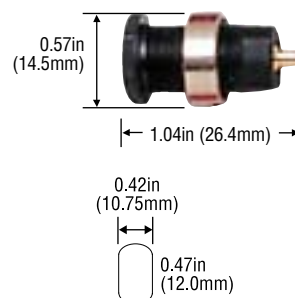

Panel Cut-Out

Model# 5931-*

Accepts flexible test lead sets 5907A, 5908A, 5909A available on page 68.

Max. Panel Thickness: 0.28in (7.0mm).

Insulation: Nylon.

Rating: 1000 V Cat III per IEC61010-031 and IEC61010-1, 25A.

*Std. Colors: -0 Black, -2 Red, -6 Blue, -9 White.

Sold in pkgs. of 10 per color.

Banana Plugs and Jacks

Panel Mount Banana Jacks with Mounting Base

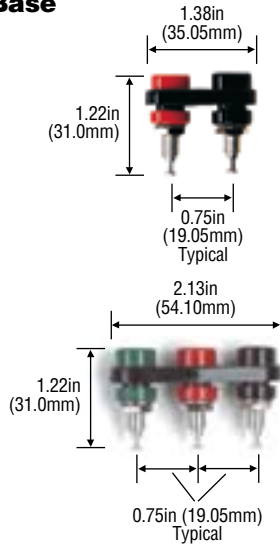

Model#	Mounting Base
2269-*	Double
5233-0	Double High-Temp
4601-*	Triple

Mounts in panels from 0.063in (1.60mm) to 0.375in (9.53mm) thick. One black, one red. Triple has green.

Rating: For CE compliance and for personal safety, do not hold in hand when voltages exceed 33 Vrms/70 Vdc. Maximum voltage for *hands free use*: 2500 Vdc. Do not use on circuits where transient stresses can exceed the rated voltage. 15A.

Temp: +239F (+115°C) [5233-0: +220°F (+428°C)].

*Mounting base color: -0 Black, -2 Red.

Replacement hex nuts available on page 35.

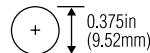

Panel Cut-Out

Terminal Strip Adapter, 4mm Safety Banana Jack to 6/32



Model# 6720

Easily connect your DMM safety sheathed test leads to terminal strips via this handy 6/32 thread adapter.

Material: Contacts: nickel-plated brass, Insulation: lucel acetal polymer.

Rating: For CE compliance and for personal safety, do not hold in hand when voltages exceed 33 Vrms/70 Vdc. (14 to 212°F) -10 to +100°C.

*Std. Colors: -0 Black, -2 Red.

Banana Jack with Wire Wrap Terminal

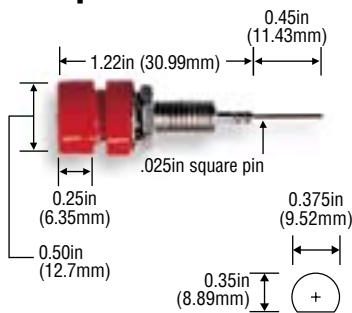

Panel Cut-Out

Model# 4005-*

Material: Jack: nickel-plated brass; Terminal: gold-plated phosphor bronze; Insulation: polycarbonate.

Rating: For CE compliance and for personal safety, do not hold in hand when voltages exceed 33 Vrms/70 Vdc. Maximum voltage for *hands free use*: 2500 Vdc. Do not use on circuits where transient stresses can exceed the rated voltage. 3A, +239°F (+115°C) max.

*Std. Colors: -0 Black, -2 Red.

Sold in pkgs. of 10 per color.

Replacement hex nuts available on page 35.

Panel Mount Banana Jack

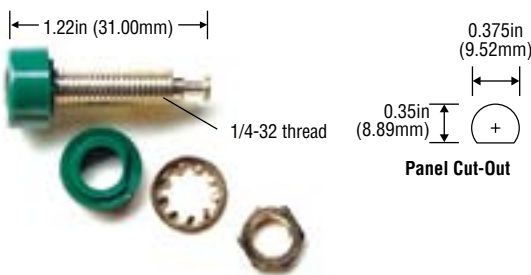

Panel Cut-Out

Model#	Plating	Insulation	Std. Colors
1581-*	Bright tin	Polycarbonate	-0 Black, -1 Brown, -2 Red, -3 Orange, -4 Yellow, -5 Green, -6 Blue, -7 Violet, -8 Gray, -9 White
2854-*	Gold	Polycarbonate	-0 Black, -1 Brown, -2 Red, -4 Yellow, -5 Green, -6 Blue, -8 Gray, -9 White
4900-*	Bright tin	Polyphenylene Sulfide	-0 Black, -6 Blue

Mounts in panels ranging in thickness from 0.063in (1.60mm) to 0.375in (9.53mm).

Material: Brass.

Rating: For CE compliance and for personal safety, do not hold in hand when voltages exceed 33 Vrms/70 Vdc. Maximum voltage for *hands free use*: 2500 Vdc. Do not use on circuits where

transient stresses can exceed the rated voltage. 15A, +239°F (+115°C) max. (Model 4900, +428°F (+220°C) max.).

Mounting Bases and replacement hex nuts available on page 34-35.

Sold in pkgs. of 10 per color.

Panel Mount Banana Jacks for Sheathed Plugs

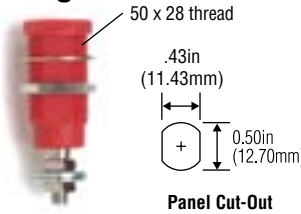

Panel Cut-Out

6387-T-P-C



ST

Model#	Std. Colors
6387-ST-T-*	-0 Black, -2 Red

These banana jacks fit most DMM plugs and all sheathed Pomona plugs. Available with several different terminals. Threaded and press-in style.

Rating: Designed to meet IEC61010 CAT III 1000 Vrms., 15A.

Sold in packages of 10.

Comes with Hex Nut and Lock Washer.

Replacement hex nuts available on page 35.

Color Options: -0 Black, -2 Red.

Plating Option: T= Tin

Terminal Type: ST=Solder Turret

Uninsulated Banana Jack

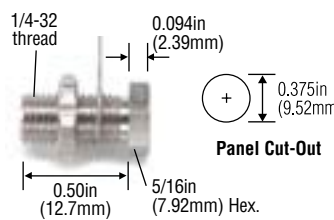

Panel Cut-Out

Model# 3267

Fits standard banana plug.

Material: nickel-plated brass.

Rating: For CE compliance and for personal safety, do not hold in hand when voltages exceed 33 Vrms/70 Vdc. Maximum voltage for *hands free use*: 5000 Vdc. Do not use on circuits where transient stresses can exceed the rated voltage. 15A.

Replacement hex nuts available on page 35.

Terminal Strip Banana Jack Adapter



This adapter provides a banana jack connection by replacing the screw in a terminal strip. Secure connections can be made with standard banana plug patch cords without breaking the connection to the terminal strip. Banana jack 0.166in (4.22mm) dia.

Material: Banana Jack: nickel-plated brass; Insulation: Nylon.

*Std. Colors: -0 Black, -2 Red, -3 Orange, -4 Yellow, -9 White.

Ratings: For CE compliance and for personal safety, do not hold in hand when voltages exceed 33 Vrms/70 Vdc. Maximum voltage for *hands free use*: (see chart for Vrms for each model#). Do not use on circuits where transient stresses can exceed the rated voltage. 25A, +216°F (+102°C) max.

Model#	Thread	Vrms	Torque In/Lb	X Stud Length
5699-*	6-32	1100	7	0.25in (6.35mm)
5700-*	8-32	1600	16	0.32in (8.13mm)
5701-*	10-32	1700	25	0.32in (8.13mm)

Banana Plugs and Jacks

Binding Posts

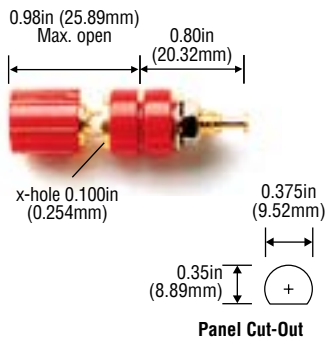

Model#	Material
3750-*	Gold-plated brass
3760-*	Bright tin-plated brass
3770-*	Gold-plated tellurium copper

Insulation: Polycarbonate.

Rating: For CE compliance and for personal safety, do not hold in hand when voltages exceed 33 Vrms/70 Vdc. Maximum voltage for *hands free use*: 2500 Vdc. Do not use on circuits where transient stresses can exceed the rated voltage. 15A, +239°F (+115°C) max.

*Std. Colors: 3750 and 3760: all 10 colors. 3770: -0 Black, -2 Red.

Sold unassembled.

Hex Head Binding Post

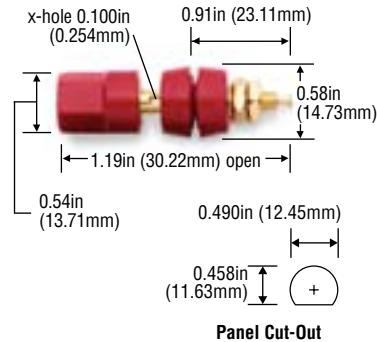

Model# 5018-*

Meets MIL-P-55149/1A.

Material: Binding Post Body, Nuts, Lockwasher: gold-plated brass; Insulation: Nylon MIL-P-20693.

Rating: For CE compliance and for personal safety, do not hold in hand when voltages exceed 33 Vrms/70 Vdc. Maximum voltage for *hands free use*: 1500 Vrms. Do not use on circuits where transient stresses can exceed the rated voltage. 30A, +176° (+80°C) max.

*Std. Colors: -0 Black, -2 Red, -4 Yellow, -5 Green, -6 Blue, -9 White.

Binding Post with Double Mounting

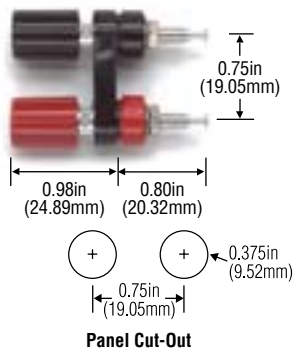

Model# 4243-*

Accepts standard banana plugs and 0.080in (2.03mm) pin tips, wires and probe tips in 0.10in (2.54mm) cross-hole.

One black and one red binding post.

Material: Binding Post: bright tin-plated brass; Insulation: polycarbonate.

Rating: For CE compliance and for personal safety, do not hold in hand when voltages exceed 33 Vrms/70 Vdc. Maximum voltage for *hands free use*: 2500 Vdc. Do not use on circuits where transient stresses can exceed the rated voltage. 15A, +239°F (+115°C) max.

*Mtg. Base Colors: -0 Black, -2 Red.

Spring Loaded Binding Post

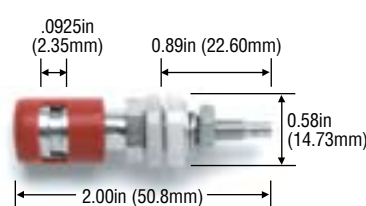

Model# 4995-*

Meets MIL-P-55149/8.

Silicone rubber O-rings provide water resistant seal when mounted in panels from 0.062in to 0.125in (15.75mm to 3.18mm) thick.

Material: Nickel-plated brass.

*Std. Colors: -0 Black, -2 Red.

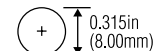

Panel Cut-Out

Dual Binding Posts

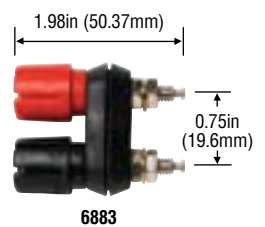

Model#	Base
6883	Standard
6884	Raised Base

5-way binding post with 3.91 mm (0.154 in) cross-hole that accepts up to 12 AWG wire and standard banana plugs. Posts are spaced at the standard 3/4 inch spacing to mate to dual banana plugs.

Material: Binding Post: nickel-plated brass. Insulators: nylon.

Rating: 30A current.

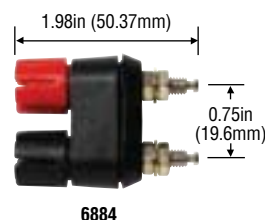

Panel Cut-Out for 6883/6884

Spring Loaded Binding Post



Model# 4770-*

Mounts in panels from 0.06in (1.6mm) to 0.38in (9.53mm) thick.

Accepts wires or plugs up to 0.08in (2.16mm) dia. with insulation up to 0.16in (4.06mm).

Material: Body: tin plated brass; Insulation: polycarbonate.

Rating: For CE compliance and for personal safety, do not hold in hand when voltages exceed 33 Vrms/70 Vdc. Maximum voltage for *hands free use*: 630 Vdc. Do not use on circuits where transient stresses can exceed the rated voltage. 15A, +239°F (+115°C) max.

*Std. Colors: -0 Black, -2 Red.

Binding Post/Banana Jack Mounting Bases

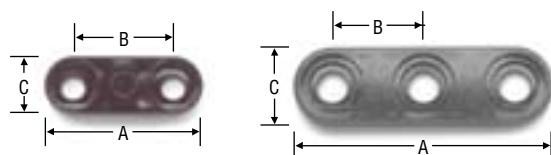

For binding post models 3750, 3760, 3770

Model#	Type	Used with	A	B	C
3862-*	Double	Standard	1.19in (30.22mm)	0.75in (19.05mm)	0.44in (11.18mm)
3863-*	Triple	Binding Posts	1.94in (49.28mm)	0.75in (19.05mm)	0.44in (11.18mm)
4619-*	Double	Miniature	0.87in (22.09mm)	0.50in (12.70mm)	0.38in (9.65mm)
4614-*	Triple	Banana Jacks	1.38in (35.05mm)	0.50in (12.70mm)	0.38in (9.65mm)
4654-*	Double	Standard	1.38in (35.05mm)	0.75in (19.05mm)	0.63in (16.00mm)
4590-*	Triple	Banana Jacks	2.13in (54.10mm)	0.75in (19.05mm)	0.63in (16.00mm)

Mount banana jacks and binding posts at standard 0.75in (19.05mm) spacing.

Material: polycarbonate

Rating: +239°F (+115°C) Max.

*Std. Colors: -0 Black.

Sold in pkgs. of 10.

Banana Plugs and Jacks

Shorting Link for Standard Binding Posts

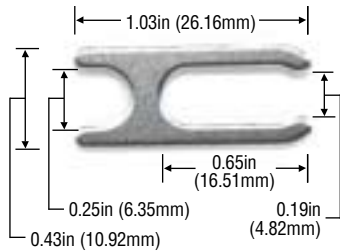

Model# 4115

Solid shorting link for binding posts.

Material: nickel-plated brass.

Rating: 15A.

Sold in pkgs. of 10.

Fits Binding Posts on 0.750in (19.05mm) centers.

Miniature Solder Type Banana Plug

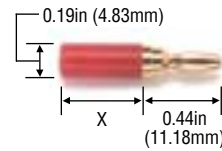

Model# Insulator Length (X)

3690-*	0.45in (11.43mm)
4617-*	1.00in (25.14mm)

Sold in pkgs. of 10

Material: Banana Plug Body: brass; Spring: beryllium copper; Finish: gold plating; Insulation: nylon.

Rating: For CE compliance and for personal safety, do not hold in hand when voltages exceed 33 Vrms/70 Vdc. Maximum voltage for hands free use: 2500 Vdc. Do not use on circuits where transient stresses can exceed the rated voltage. 5A, +176°F (+80°C) max.

*Std. Colors: -0 Black, -2 Red.

Fits miniature 0.104in (2.64mm) dia. banana jacks.

Miniature Double Banana Plug with Set Screws, Stackable, Solderless

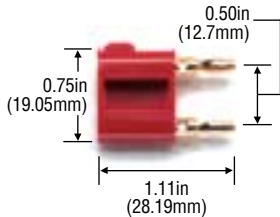

Model# 2244-*

Internal set screws secure cable up to 0.15in (3.81mm) dia. or components.

Plugs fit miniature 0.104in (2.64mm) dia. jacks.

Material: Banana Plug/Jack: brass; Spring: beryllium copper; Finish: gold plating; Insulation: ABS

Rating: For CE compliance and for personal safety, do not hold in hand when voltages exceed 33 Vrms/70 Vdc. Maximum voltage for hands free use: 2500 Vdc. Do not use on circuits where transient stresses can exceed the rated voltage. 5A, +122°F (+50°C) max.

*Std. Colors: -0 Black, -2 Red.

Miniature Banana Plug with Threaded Stud

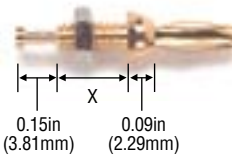

Model# X Length

3276	0.230in (5.84mm)
4513	0.480in (12.19mm)

Fits miniature 0.104in (2.64mm) dia. banana jacks.

Furnished with 4-40 hex nut, 4-40 threaded stud.

Material: Banana Plug Body: brass; Spring: beryllium copper; Finish: gold plating.

Rating: For CE compliance and for personal safety, do not hold in hand when voltages exceed 33 Vrms/70 Vdc. Maximum voltage for hands free use: 2500 Vdc. Do not use on circuits where transient stresses can exceed the rated voltage. 5A.

Replacement hex nut available on page 35.

Sold unassembled, in pkgs. of 10.

Miniature Solderless Type Triple Banana Plug with Wire Guide

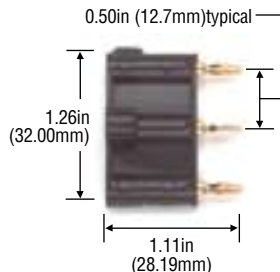

Model# 4653-0

Use for balanced line 2 conductor shielded cable assemblies.

Material: Banana Plug/Jack: brass; Spring: beryllium copper; Finish: gold plating; Insulation: ABS.

Rating: For CE compliance and for personal safety, do not hold in hand when voltages exceed 33 Vrms/70 Vdc. Maximum voltage for hands free use: 2500 Vdc. Do not use on circuits where transient stresses can exceed the rated voltage. 5A, +122°F (+50°C) max.

Cable strain relief I.D. 0.19in (4.82mm).

Setscrews secure wires.

Do-It-Yourself Miniature Banana Plug, Stackable, Solderless

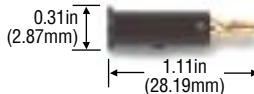

Model# 2944-*

Fits miniature 0.104in (2.64mm) dia. banana jacks.

Wire firmly held in place with internal set screw.

Material: Banana Plug/Jack: brass; Spring: beryllium copper; Finish: gold plating; Insulation: ABS.

Rating: For CE compliance and for personal safety, do not hold in hand when voltages exceed 33 Vrms/70 Vdc. Maximum voltage for hands free use: 2500 Vdc. Do not use on circuits where transient stresses can exceed the rated voltage. 5A, +122°F (+50°C) max.

*Std. Colors: -0 Black, -2 Red.

Do-It-Yourself Miniature Banana Plug with Safety Shield, Stackable, Solderless

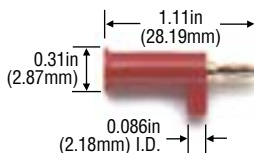

Model# 2945-*

Fits miniature 0.104in (2.64mm) dia. banana jacks.

Wire firmly held in place with internal set screw.

Material: Banana Plug/Jack: brass; Spring: beryllium copper; Finish: gold plating; Insulation: ABS

Rating: For CE compliance and for personal safety, do not hold in hand when voltages exceed 33 Vrms/70 Vdc. Maximum voltage for hands free use: 2500 Vdc. Do not use on circuits where transient stresses can exceed the rated voltage. 5A, +122°F (+50°C) max.

*Std. Colors: -0 Black, -2 Red.

Miniature Double Banana Plug with Shorting Bar

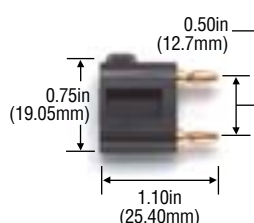

Model# 2035-*

Plugs fit miniature 0.104in (2.64mm) dia. banana jacks.

Banana plugs internally shorted with 18 AWG wire.

Material: Banana Plug/Jack: brass; Spring: beryllium copper; Finish: gold plating; Insulation: ABS.

Rating: For CE compliance and for personal safety, do not hold in hand when voltages exceed 33 Vrms/70 Vdc. Maximum voltage for hands free use: 2500 Vdc. Do not use on circuits where transient stresses can exceed the rated voltage. 5A, +122°F (+50°C) max.

*Std. Colors: -0 Black, -2 Red.

Replacement Hex Nuts



Model#	Qty.	Finish	Wrench Size	Nut Thickness	Thread
6549	500	Nickel	3/16in	0.65in (16.51mm)	4-40
6547	500	Nickel	1/4in	0.95in (24.13mm)	6-32
6440	500	Nickel	1/4in	0.95in (24.13mm)	8-32
6548	100	Gold	3/8in	0.95in (24.13mm)	10-32
6441	500	Nickel	3/8in	0.95in (24.13mm)	1/4-32
6389	100	Nickel	9/16in	0.95in (24.13mm)	1/2-28

Hex Nut	6549	6547	6440	6548	6441	6389	
Fits on	3276 4513	3263 4511 6271	2142 2143 2382 2383 2439 2440 3264 3542 3750 3760	3770 4022 4098 4243 4512 4543 4773 6272	5018	1581 2269 2854 3267 4005 4069 4601 4900 5233 6270	4921 6387

*Color Code: -0 Black, -1 Brown, -2 Red, -3 Orange, -4 Yellow, -5 Green, -6 Blue, -7 Violet, -8 Gray, -9 White

Miniature Double Banana Plug Shorting Bar

Model# 3030

Center hole accepts 4-40 screw.

Material: Banana Plug Body: brass; Spring: beryllium copper; Finish: gold plating.

Rating: 5A. Resistance less than 1.5 m.

Fits Miniature Binding Posts and Miniature Banana Jacks on 0.5in (12.70mm) centers.

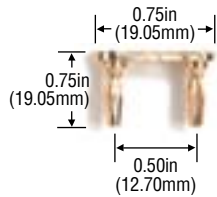

Miniature Rivet Type Banana Plug

Model#	Panel	X Dim.
3268	0.062in (1.57mm)	0.094in (2.39mm)
3271	0.093in (2.36mm)	0.125in (3.17mm)
3272	0.125in (3.17mm)	0.156in (3.96mm)

Fits miniature 0.104in (2.64mm) dia. banana jacks.

Material: Banana Plug Body: brass; Spring: beryllium copper; Finish: gold plating.

Rating: For CE compliance and for personal safety, do not hold in hand when voltages exceed 33 Vrms/70 Vdc. Maximum voltage for hands free use: 2500 Vdc. Do not use on circuits where transient stresses can exceed the rated voltage. 5A.

Sold in pkgs. of 10.

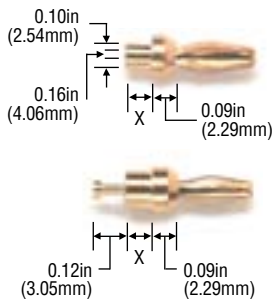

Miniature Binding Post

Model#	Plating
2382-*	Gold
2439-*	Tin

Accepts miniature banana plug.

8-32 hex nut and lockwasher included.

Material: Binding Post Body, Nut: brass; Lockwasher: steel; Insulation: polycarbonate.

Rating: For CE compliance and for personal safety, do not hold in hand when voltages exceed 33 Vrms/70 Vdc. Maximum voltage for hands free use: 1500 Vdc. Do not use on circuits where transient stresses can exceed the rated voltage. 5A, +239°F (+115°C) max.

*Std. Colors: -0 Black, -2 Red, -5 Green, -6 Blue.

Replacement hex nuts available on page 35.

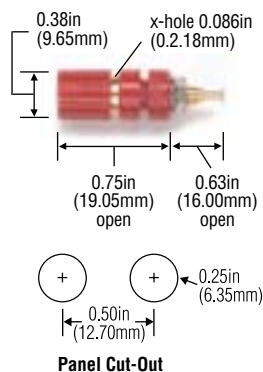

Miniature Banana Jack with Wire Wrap Terminal

Model# 4022-*

Accepts miniature banana plugs.

Mounts in panels up to 0.250in (6.35mm) thick.

Material: Jack: nickel-plated brass; Terminal: gold-plated phosphor bronze; Insulation: polycarbonate.

Rating: For CE compliance and for personal safety, do not hold in hand when voltages exceed 33 Vrms/70 Vdc. Maximum voltage for hands free use: 1500 Vdc. Do not use on circuits where transient stresses can exceed the rated voltage. 3A, +239°F (+115°C) max.

*Std. Colors: -0 Black, -2 Red.

Sold unassembled, in pkgs. of 10.

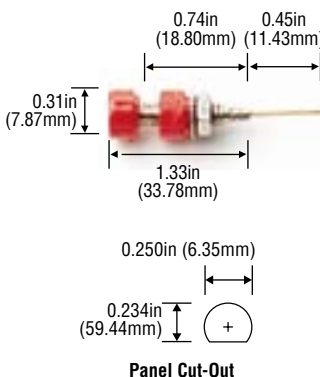

Miniature Insulated Binding Post with Double Mounting Base

Model#	Plating
2383-*	Gold
2440-*	Tin

Accepts miniature banana plugs.

8-32 hex nut and lockwasher included.

Material: Binding Post Body, Nut: brass; Lockwasher: steel; Insulation: polycarbonate.

Rating: For CE compliance and for personal safety, do not hold in hand when voltages exceed 33 Vrms/70 Vdc. Maximum voltage for hands free use: 1500 Vdc. Do not use on circuits where transient stresses can exceed the rated voltage. 5A, +239°F (115°C) max.

*Mounting Base Colors: -0 Black, -2 Red.

*Std. Colors: 2383: -0 Black, -2 Red. 2440: -0 Black.

Replacement hex nuts available on page 35.

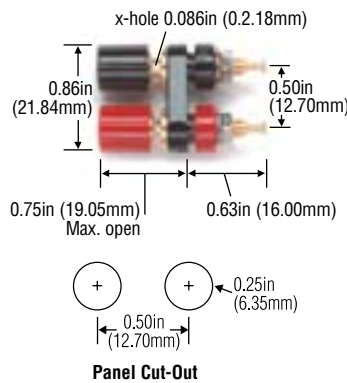

Do-It-Yourself Pin Tip Plug with Safety Shield, Stackable, Solderless

Model# 3548-*

Accepts miniature banana plug.

Wire firmly held in place with internal set screw.

Material: Pin Tip Plug/Jack: gold-plated brass; Insulation: ABS.

Rating: For CE compliance and for personal safety, do not hold in hand when voltages exceed 33 Vrms/70 Vdc. Maximum voltage for hands free use: 3000 Vdc. Do not use on circuits where transient stresses can exceed the rated voltage. 5A, +122°F (+50°C) max.

*Std. Colors: -0 Black, -2 Red.

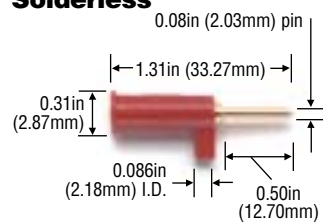

Miniature Banana Jack, Panel Mount

Model# 2142-*

Accepts miniature banana plugs. Mounts in panels up to 0.250in (6.35mm) thick.

Material: gold-plated brass; Insulation: polycarbonate.

Rating: For CE compliance and for personal safety, do not hold in hand when voltages exceed 33 Vrms/70 Vdc. Maximum voltage for hands free use: 1500 Vdc. Do not use on circuits where transient stresses can exceed the rated voltage. 5A, +239°F (+115°C) max.

*Std. Colors: -0 Black, -2 Red, -3 Orange, -4 Yellow, -5 Green, -6 Blue, -9 White.

Uses hex nut 6440.

Replacement hex nuts available on page 35.

Sold unassembled, in pkgs. of 10 per color.

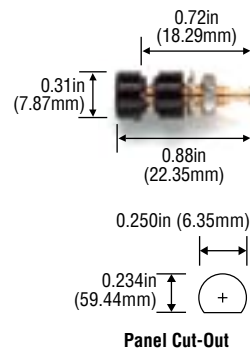

Miniature Rivet Type Banana Jack with Turret

Model# 3277

Accepts miniature banana plugs.

Mounts in panels up to 0.062in (1.57mm) thick.

Material: Gold-plated brass.

Rating: For CE compliance and for personal safety, do not hold in hand when voltages exceed 33 Vrms/70 Vdc. Maximum voltage for hands free use: 1500 Vdc. Do not use on circuits where transient stresses can exceed the rated voltage. 5A.

Sold in pkgs. of 10.

Rec. Mounting Hole: .140 ± .002 (9/64 Drill).

Panel Thickness: 0.062in (1.57mm)

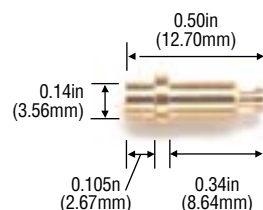

Banana Plugs and Jacks

Miniature Banana Jack in Double Mounting Base, Panel Mount

Model# 2143-*

Accepts miniature banana plugs. Mounts in panels up to 0.188in (4.78mm) thick.

Material: gold-plated brass; *Insulation:* polycarbonate.

Rating: For CE compliance and for personal safety, do not hold in hand when voltages exceed 33 Vrms/70 Vdc. Maximum voltage for *hands free use:* 1500 Vdc. Do not use on circuits where transient stresses can exceed the rated voltage. 5A, +239°F (+115°C) max.

***Std. Mounting Base Colors:** -0 Black, -2 Red.

Colors: One black and one red jack.

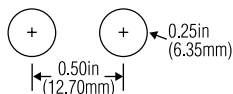
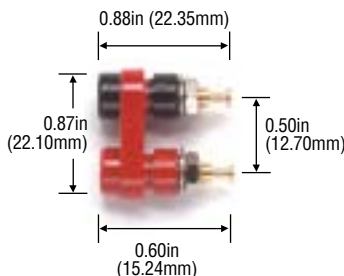

Panel Cut-Out

Double Pin Tip Plug with Shorting Bar

Model# 3452-*

Accepts pin tip plugs. Internally shorted with 20 AWG wire. Use as connecting link for 0.50in (12.70mm) spaced pin tip jacks.

Material: Pin Tip Plug/Jack: brass; Spring: beryllium copper; Finish: gold plating; *Insulation:* ABS.

Rating: For CE compliance and for personal safety, do not hold in hand when voltages exceed 33 Vrms/70 Vdc. Maximum voltage for *hands free use:* 3000 Vdc. Do not use on circuits where transient stresses can exceed the rated voltage. 5A, +239°F (+115°C) max.

***Std. Colors:** -0 Black, -2 Red.

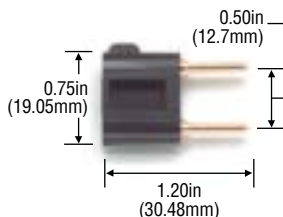

Do-It-Yourself .080in (20.32mm) Dia. Pin Tip Plug with Flexible Boot, Solder or Crimp

Model# 5173-*

Accepts Wire AWG 22, 20, 18

Ideal for making patch cords or field repairs. Snap-on flexible PVC boot allows wire to be crimped or soldered to pin tip plug.

Material: nickel-plated brass.

Accepts 18-22 AWG wire.

Rating: For CE compliance and for personal safety, do not hold in hand when voltages exceed 33 Vrms/70 Vdc. Maximum voltage for *hands free use:* 3000 Vdc. Do not use on circuits where transient stresses can exceed the rated voltage. 5A, +122°F (+50°C) max.

***Std. Colors:** Available in 10 colors.

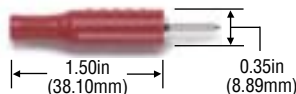

Double Banana Jack to Miniature Double Banana Plug Plug

Model# 2952

Converts standard banana plugs to miniature.

Material: Jack: nickel-plated brass; Spring: nickel-plated beryllium copper; *Insulation:* ABS.

Rating: For CE compliance and for personal safety, do not hold in hand when voltages exceed 33 Vrms/70 Vdc. Maximum voltage for *hands free use:* 2500 Vdc. Do not use on circuits where transient stresses can exceed the rated voltage. 5A, +122°F (+50°C) max.

Color: Black.

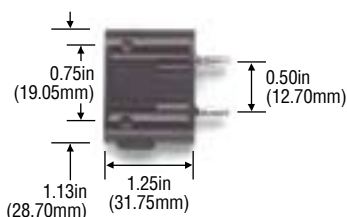

Pin Tip Jacks with Double Mounting Base

Model# 4543-*

Accepts 0.08in (2.03mm) dia. pin.

Max. panel thickness 0.188in (4.78mm).

Material: Jack: gold-plated brass; Spring: beryllium copper; *Insulation:* polycarbonate.

Rating: For CE compliance and for personal safety, do not hold in hand when voltages exceed 33 Vrms/70 Vdc. Maximum voltage for *hands free use:* 1500 Vdc. Do not use on circuits where transient stresses can exceed the rated voltage. 5A, +239°F (115°C) max.

***Mtg. Base Colors:** -0 Black, -2 Red.

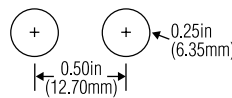
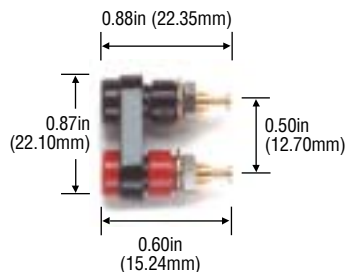

Panel Cut-Out

Pin Tip Jack

Model# 3542-*

Accepts 0.080in (2.03mm) dia. pin.

Material: Jack: gold-plated brass; Spring: beryllium copper; *Insulation:* polycarbonate.

Rating: For CE compliance and for personal safety, do not hold in hand when voltages exceed 33 Vrms/70 Vdc. Maximum voltage for *hands free use:* 1500 Vdc. Do not use on circuits where transient stresses can exceed the rated voltage. 5A, +239°F (115°C) max.

***Std. Colors:** -0 Black, -2 Red, -3 Orange, -4 Yellow, -5 Green, -6 Blue, -9 White.

Sold in pkgs. of 10.

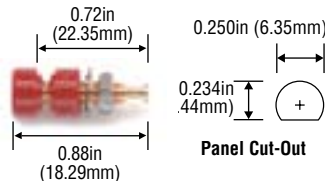

Panel Cut-Out

Insulated Pin Jack with Wire Wrap Terminal

Model# 4773-*

Accepts 0.080in (2.03mm) dia. pin.

Max. panel thickness 0.25in (6.35mm).

Material: Jack: nickel-plated brass; Spring: gold-plated beryllium copper; Terminal: gold-plated phosphor bronze; *Insulation:* polycarbonate.

Rating: For CE compliance and for personal safety, do not hold in hand when voltages exceed 33 Vrms/70 Vdc. Maximum voltage for *hands free use:* 1500 Vdc. Do not use on circuits where transient stresses can exceed the rated voltage. 3A, +239°F (+115°C) max.

***Std. Colors:** -0 Black, -2 Red, -6 Blue, -9 White.

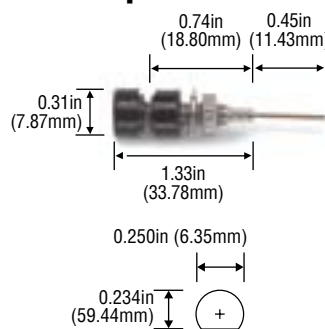

Panel Cut-Out

Miniature Banana Jack to Banana Plug

Model# 2477-*

Converts miniature banana plugs to standard.

Material: Jack: nickel-plated brass; Spring: nickel-plated beryllium copper; *Insulation:* ABS.

Rating: For CE compliance and for personal safety, do not hold in hand when voltages exceed 33 Vrms/70 Vdc. Maximum voltage for *hands free use:* 2500 Vdc. Do not use on circuits where transient stresses can exceed the rated voltage. 5A, +122°F (+50°C) max.

***Std. Color:** -0 Black, -2 Red.

Sold in pkgs. of 10.

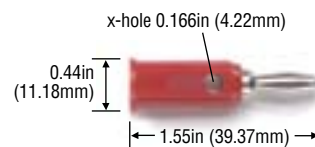

Do-It-Yourself In-Line 4 mm (0.16in) Banana Plug

Model# 5934-*

Wire connection by set screw. Accepts 18, 20 and 22 AWG wire.

Material: *Insulation:* Nylon.

Rating: For CE compliance and for personal safety, do not hold in hand when voltages exceed 33 Vrms/70 Vdc. Maximum voltage for *hands free use:* 750 Vdc. Do not use on circuits where transient stresses can exceed the rated voltage. 25A.

***Std. Colors:** -0 Black, -2 Red.

Sold in pkgs. of 10 per color.

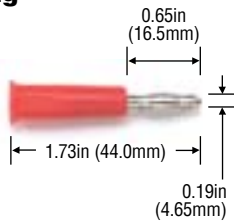

Pin Tip Jack to Banana Plug

Model# 1809-*

Accepts 0.080in (2.03mm) pin tip plug or probe tip. Fits standard 0.166in (4.22mm) dia. banana jack.

Material: gold-plated beryllium copper.

Rating: For CE compliance and for personal safety, do not hold in hand when voltages exceed 33 Vrms/70 Vdc. Maximum voltage for *hands free use:* 2500 Vdc. Do not use on circuits where transient stresses can exceed the rated voltage. 5A, +122°F (+50°C) max.

***Std. Color:** -0 Black, -2 Red.

Sold in pkgs. of 10.



Banana Jack to Pin Tip Plug

Model# 1432-*

Use to mate standard banana plug patch cords to equipment having pin jacks.

Material: *Jack/Plug:* nickel-plated brass; *Insulation:* ABS.

Rating: For CE compliance and for personal safety, do not hold in hand when voltages exceed 33 Vrms/70 Vdc. Maximum voltage for *hands free use:* 3000 Vdc. Do not use on circuits where transient stresses can exceed the rated voltage. 5A, +122°F (+50°C) max.

***Std. Colors:** -0 Black, -2 Red.

Sold in pkgs. of 10.

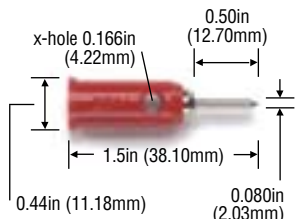

Banana Jack to .080in (2mm) Dia. Pin Tip Jack

Model# 3834-*

Adapts standard 0.166in (4.22mm) dia. banana plug to 0.080in (2.03mm) dia. pin tip plug.

Material: *Banana Jack:* nickel-plated brass; *Pin Jack:* gold-plated beryllium copper; *Insulation:* polypropylene.

Rating: For CE compliance and for personal safety, do not hold in hand when voltages exceed 33 Vrms/70 Vdc. Maximum voltage for *hands free use:* 3000 Vdc. Do not use on circuits where transient stresses can exceed the rated voltage. 5A, +131°F (+55°C) max.

***Std Colors:** -0 Black.



2mm Banana Jack

Model# 5935-*

Max. Panel Thickness: 0.31in (8mm).

Material: *Insulation:* nylon; *Finish:* nickel plating.

Rating: For CE compliance and for personal safety, do not hold in hand when voltages exceed 33 Vrms/70 Vdc. Maximum voltage for *hands free use:* 500 Vdc. Do not use on circuits where transient stresses can exceed the rated voltage. 5A, ≤ 2 mΩ.

***Std. Colors:** -0 Black.

Sold in pkgs. of 10 per color.

Not compatible with Miniature Banana Plug or Pin Tip.

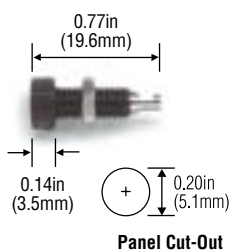

Double Banana Plug with Binding Posts, Stackable, Solderless

Model#	Plating
1286	Nickel
5405	Gold

Features insulated binding posts on 0.750in (19.05mm) centers for rapid mounting and interchangeability of components. Center cross hole 0.166in (4.22mm) dia. provides side stackup connection.

Material: *Binding Post/Banana Plug Body:* brass; *Spring:* beryllium copper; *Insulation:* ABS.

Rating: For CE compliance and for personal safety, do not hold in hand when voltages exceed 33 Vrms/70 Vdc. Maximum voltage for *hands free use:* 2500 Vdc. Do not use on circuits where transient stresses can exceed the rated voltage. 15A, +122°F (+50°C) max.

Color: Black.

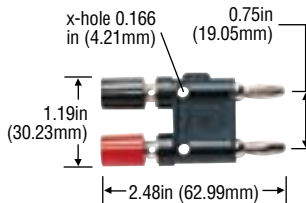

Banana Jack to Miniature Banana Plug

Model# 2138-*

Use to mate standard 0.166in (4.22mm) dia. banana plug to equipment having miniature banana jacks.

Material: *Jack:* nickel-plated brass; *Spring:* nickel-plated beryllium copper; *Insulation:* ABS.

Rating: For CE compliance and for personal safety, do not hold in hand when voltages exceed 33 Vrms/70 Vdc. Maximum voltage for *hands free use:* 2500 Vdc. Do not use on circuits where transient stresses can exceed the rated voltage. 5A, +122°F (+50°C) max.

***Std. Color:** -0 Black, -2 Red.

Sold in pkgs. of 10.

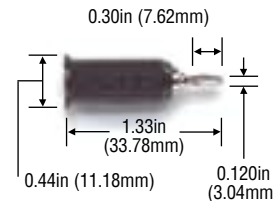

Insulated Double Banana Plug Shorting Bar with Binding Post

Model# 5165-*

Fits standard banana jack.

Shorting bar is completely insulated in clear ABS thermoplastic.

Material: *Binding Post/Banana Plug Body/Shorting Bar:* nickel-plated brass; *Spring:* nickel-plated beryllium copper; *Insulation:* polycarbonate.

Rating: For CE compliance and for personal safety, do not hold in hand when voltages exceed 33 Vrms/70 Vdc. Maximum voltage for *hands free use:* 2500 Vdc. Do not use on circuits where transient stresses can exceed the rated voltage. 15A, +122°F (+50°C) max.

***Binding Post Colors:** -0 Black, -2 Red.

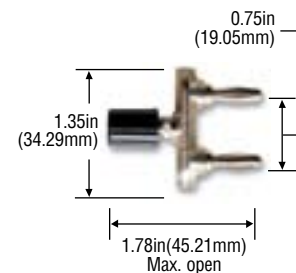

Binding Post to Banana Plug

Model# 2894-*

Features insulated binding post for rapid mounting and interchangeability of components. Accepts standard banana plug. Center cross hole 0.166in (4.22mm) dia. provides side stackup connection.

Material: *Binding Post/Banana Plug Body:* nickel-plated brass; *Spring:* nickel-plated beryllium copper; *Insulation:* ABS

Rating: For CE compliance and for personal safety, do not hold in hand when voltages exceed 33 Vrms/70 Vdc. Maximum voltage for *hands free use:* 2500 Vdc. Do not use on circuits where transient stresses can exceed the rated voltage. 15A, +122°F (+50°C) max.

***Binding Post Colors:** -0 Black, -2 Red.



Banana Plugs and Jacks

2mm Banana Plug

Model# 5936-*



Solder type wire connection.

Accepts 18-22 AWG wire.

Rating: For CE compliance and for personal safety, do not hold in hand when voltages exceed 33 Vrms/70 Vdc. Maximum voltage for *hands free use*: 500 Vrms. Do not use on circuits where transient stresses can exceed the rated voltage. 5A, ≤ 2 m Ω .

*Std. Colors: -0 Black, -2 Red.

Assembled Length: 1.07in (27.2 mm).

Sold unassembled, in pkgs. of 10 per color.

Not compatible with Miniature Banana Plug or Pin Tip.

Test Connector Adapter Set

Model# 6481

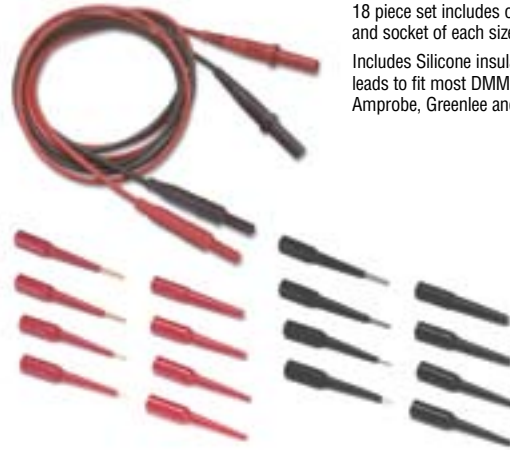

Full set of pin and socket adapters.

18 piece set includes one black and red pin and socket of each size.

Includes Silicone insulated 4ft (1.21m) leads to fit most DMMs from Fluke, Amprobe, Greenlee and others.

Spade Lug to DMM Banana Jack

Model#	A	B	Lug Size
3744A-*	0.14in (3.56mm)	0.24in (6.10mm)	4, 5, 6
3777A-*	0.2in (5.0mm)	0.30in (7.7mm)	8, 10



Plugs into DMM leads. Permits DMM leads to be used with equipment having barrier strips, or binding post.

Material: Banana Jack: nickel-plated brass; Spade Lug: tin-plated copper; Insulation: polypropylene.

Rating: For CE compliance and for personal safety, do not hold in hand when voltages exceed 33 Vrms/70 Vdc. Maximum voltage for *hands free use*: 5000 Vdc. Do not use on circuits where transient stresses can exceed the rated voltage. 15A, +122°F (+50°C) max.

*Std. Colors: -0 Black, -2 Red, -02 Set of one black and one red.

Low Thermal EMF Insulated Spade Lug to Banana Jack

Model# 2305

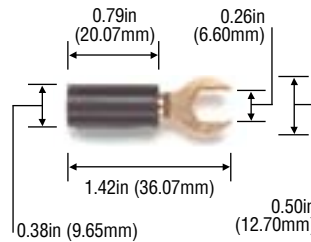

Special alloy and plating preserve the accuracy of low voltage measurement equipment. Thermal effects are minimized. Heavy construction for minimum voltage loss. Mates with low voltage banana plug patch cords and binding posts.

Material: Jack and Spade Lug: gold-plated tellurium copper; Insulation: ABS.

Rating: For CE compliance and for personal safety, do not hold in hand when voltages exceed 33 Vrms/70 Vdc. Maximum voltage for *hands free use*: 5000 Vdc. Do not use on circuits where transient stresses can exceed the rated voltage. 15A, +122°F (+50°C) max.

Set of one red and one black.

Connector Test Adapters

Pin type



Socket type

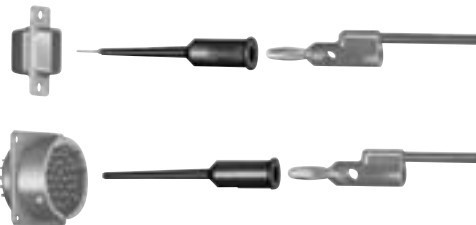

Model#	AWG	Contact Size	Type	Current Rating
4690-*	22	0.030in (0.76mm)	Socket	3A
4691-*			Pin	
3560-*	20	0.040in (1.02mm)	Socket	
3561-*			Pin	
3562-*	16	0.063in (1.60mm)	Socket	
3563-*			Pin	
3564-*	12	0.093in (2.36mm)	Socket	
3565-*			Pin	

An ideal test adapter for rapid testing of the hard-to-get at contacts of multi-pin/socket connectors. Flexible tip allows testing of adjacent contacts. Flexibility and full insulation protects against shorting or contact damage. Model 4690 also fits 0.025in (0.63mm) sq. pins.

Material: Banana Jack: nickel-plated brass; Socket: gold-plated copper; Pin: gold-plated brass; Insulation: PVC.

Rating: For CE compliance and for personal safety, do not hold in hand when voltages exceed 33 Vrms/70 Vdc. Maximum voltage for *hands free use*: 2500 Vdc. Do not use on circuits where transient stresses can exceed the rated voltage. +122°F (+50°C) max.

*Std. Colors: -0 Black, -2 Red.